

**Roto**<sup>®</sup>  
**Ultra**



**45+**  
years of  
*...moving fluids positively*



Efficient pumping solutions  
for paper industry

## Roto Pumps in Pulp & Paper Industry

Roto Pumps has a vintage of over 45 years in providing fluid handling solution to a spectrum of Industries. These pumps can handle wide variety of fluids ranging from clean and clear liquids to abrasive, corrosive, viscous and solid laden media. In paper industry these pumps are used in all major stages including Pulp Making, Pulp preparation and Kitchen Coating. Some of the few design features include:

- Flow proportionate to Speed - Can be used for Dosing and metering applications
- Self Priming - Excellent Suction Lift Capability and can operate under vacuum
- Non-Clogging - Can handle solids in suspension
- Low Internal Velocity - Can handle shear sensitive media
- Positive Displacement - Flow independent of Head
- Will not Vapor Lock - Can handle air, liquid and combination together



### RJ series pump for precise metering applications

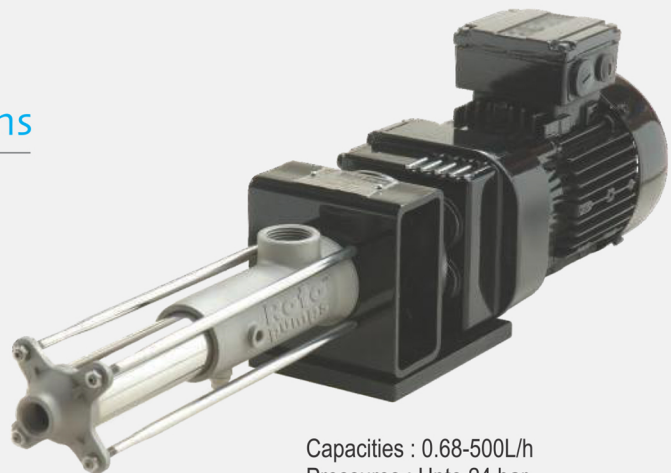

Capacities : 0.68-500L/h  
Pressures : Upto 24 bar

### RJ series of dosing pumps

Roto RJ series pumps are developed for low flow applications that demand high accuracies and repeatability. These pumps can handle wide variety of fluids ranging from clean and clear liquids to abrasive, corrosive, viscous and solid laden media.

### Advantages

- High dosing accuracies - fluctuation  $\pm 1\%$ .
- Smooth and non - pulsating flow - no need of pulsation dampners.
- Low sheer and linear flow - can handle sheer sensitive media.
- Single rotating element - no valves or gears required.

## FLOW DIAGRAM OF A TYPICAL

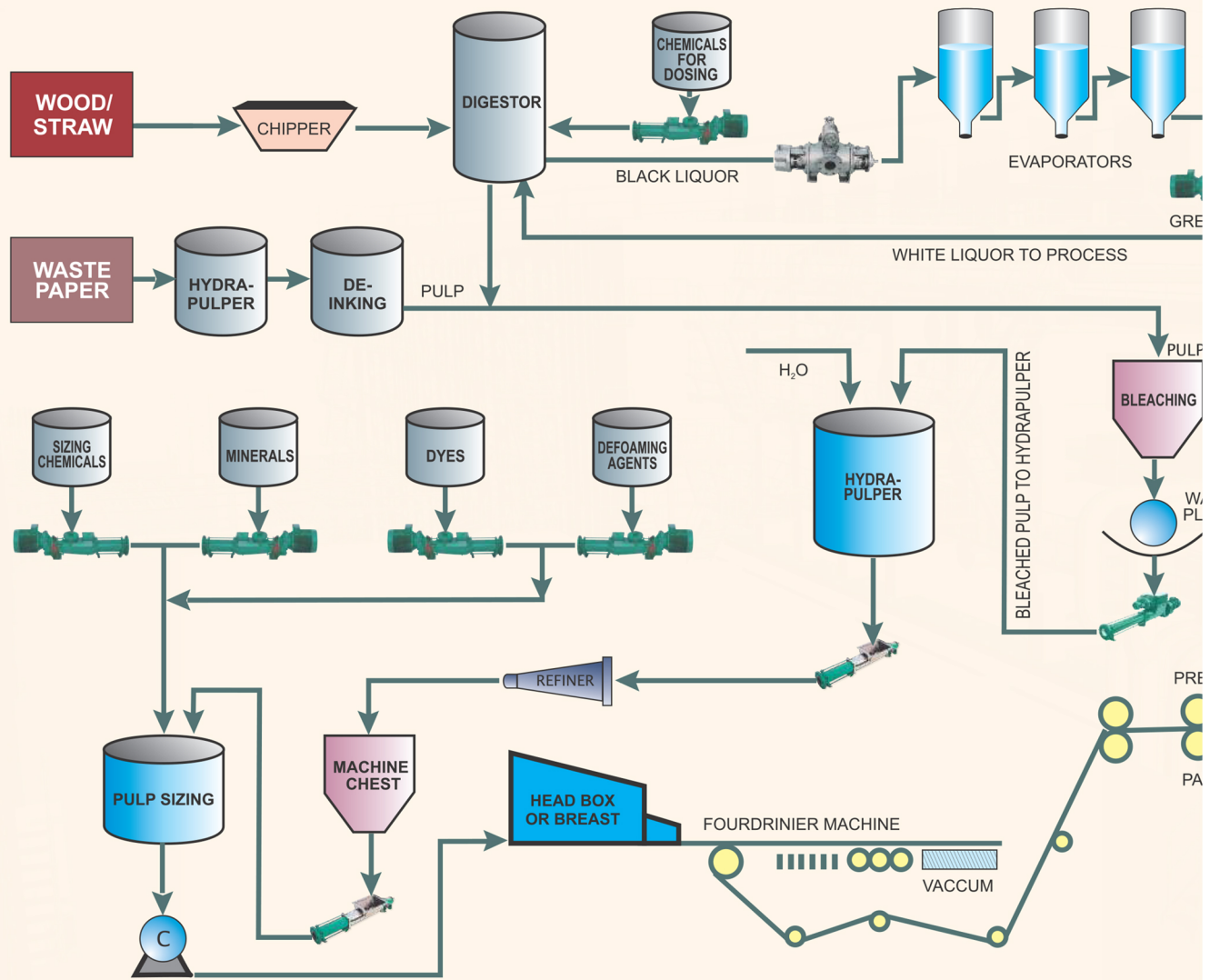

## APPLICATIONS :

### Pulp Making Process

- Black Liquor
- Green Liquor
- Sodium Hydroxide
- Sodium Sulphide
- Sodium Carbonate
- Decolouring Agent
- High Density Pulp

### Pulp Preparation Process

- Sizing Chemicals
- Rosin
- Neutral Sizing
- Calcium Carbonate
- Alkyl Ketens Dimmer( AKD)
- Alkenyl Succinic Anhydride (ASA)
- Mineral Filler
- Talcum
- Kaolin
- Calcium Carbonate
- Carbon Dioxide
- Low Density Pulp
- Pigment
- Colour
- Optics
- Defoamers
- Retainers
- Paper
- Fiber



# CAL PULP AND PAPER INDUSTRY

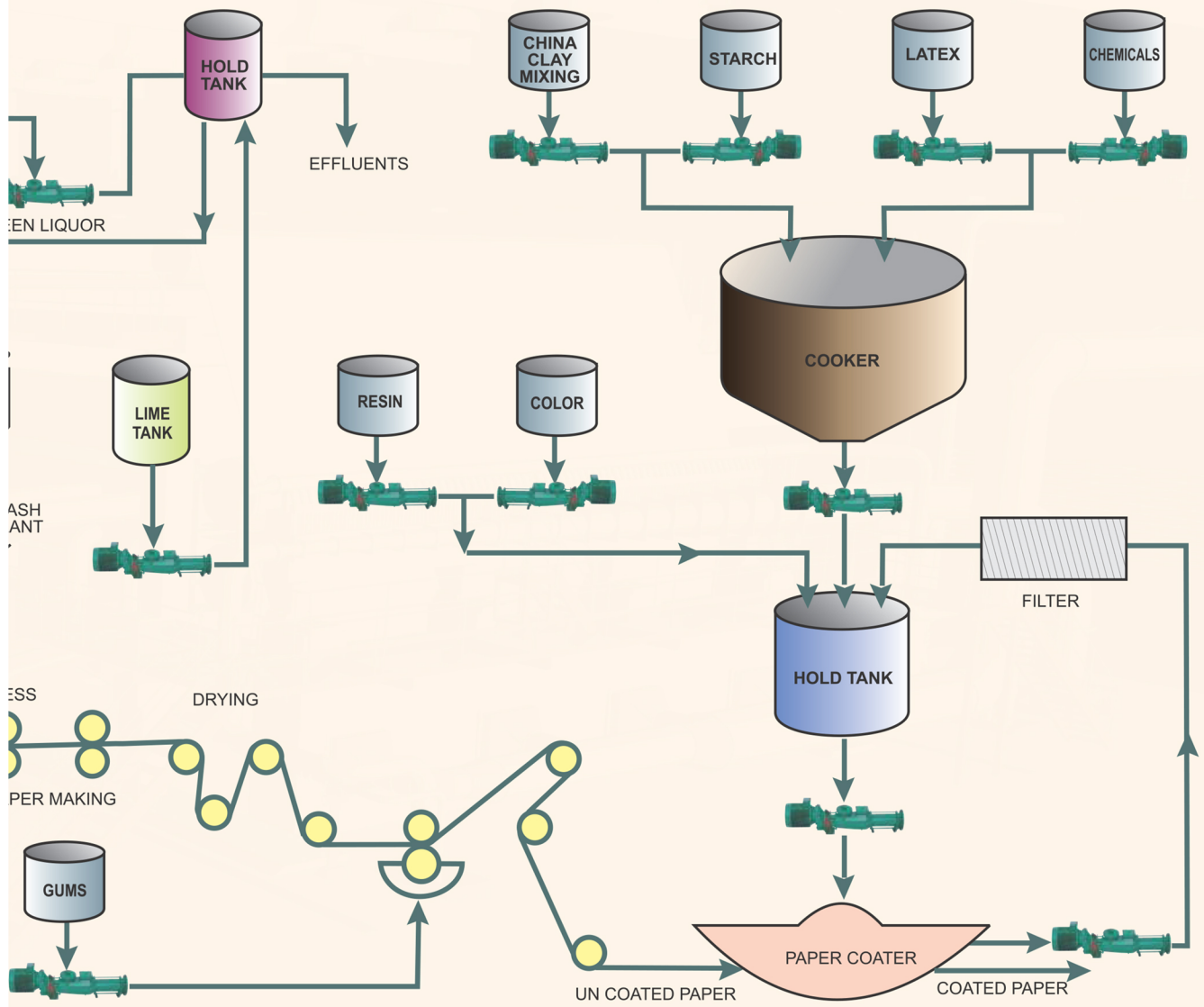

ents  
rs  
al Brightener  
aming Agents  
ning Aids  
r Softener  
Dispenser

## Paper Making Process

- Starch
- Polyvinyl Alcohol
- Wax
- Latex

## Paper Coating Process

- Starch
- China Clay
- Resin
- Latex
- Chemicals
- Colour
- Kitchen Coating Slurry



**Extended Pitch Geometry**

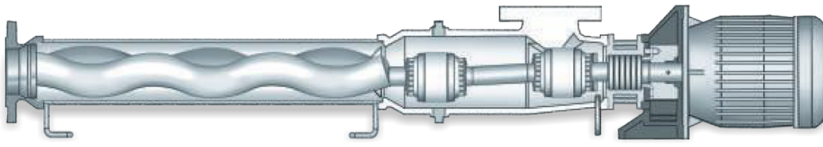

Capacities 420 M<sup>3</sup>/hr

Pressures 6 Bar

**Standard Pitch Geometry**

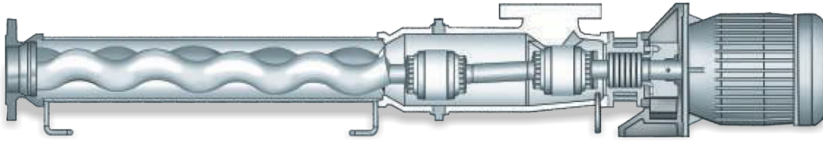

Capacities 250 M<sup>3</sup>/hr

Pressures 48 Bar

**Submerged Vertical**

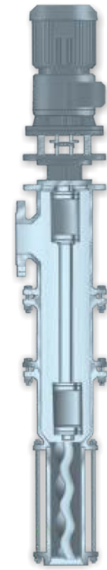

Capacities 420 M<sup>3</sup>/hr  
Pressures 12 Bar

**Wide Throat Medium Consistency**

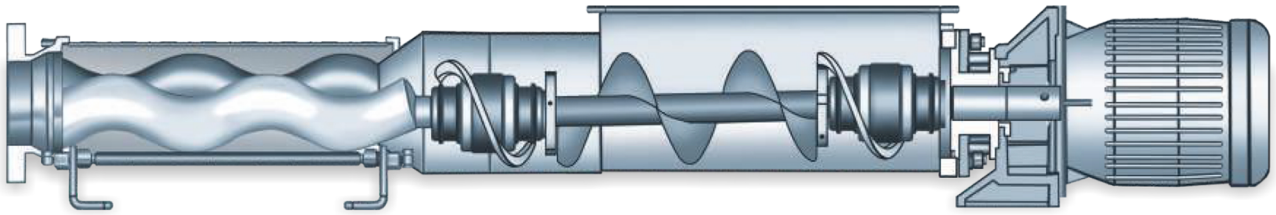

Capacities 150 M<sup>3</sup>/hr

Pressures 36 Bar

**Wide Throat High Consistency**

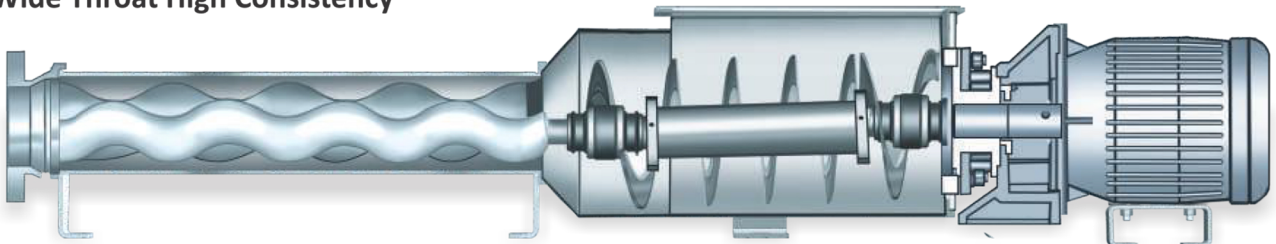

Capacities 100 M<sup>3</sup>/hr

Pressures 36 Bar

**Wide Throat High Consistency with Bridge Breaker**

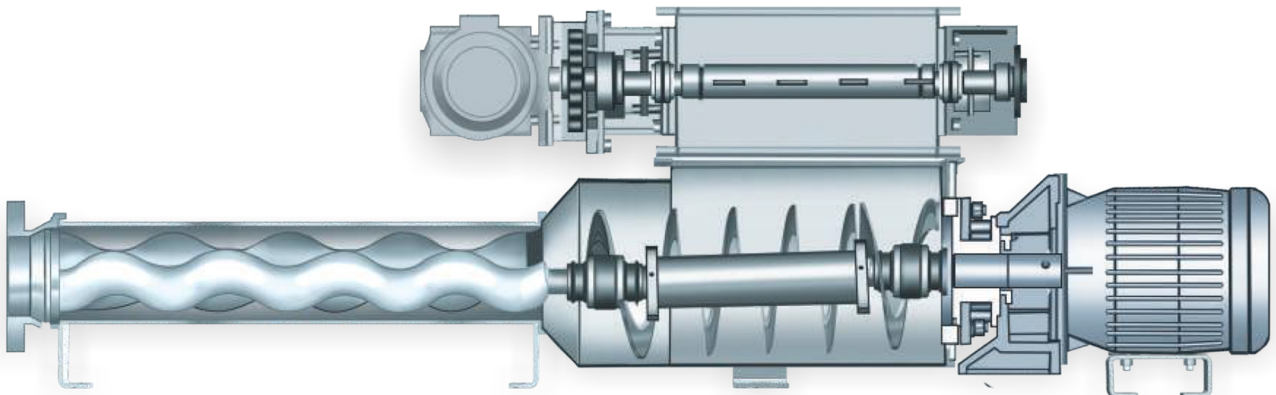

Capacities 100 M<sup>3</sup>/hr

Pressures 36 Bar

Roto Pumps Limited, Manufacturing Plant, India



Melbourne Office & Warehouse



Manchester Office & Warehouse



Roto Pumps North America, Inc



## ROTO PUMPS LTD.

### Marketing Head Office

Roto House,13, Noida Special Economic Zone, Noida - 201305, INDIA  
Tel.: +91 120 2567902-5 Fax: +91 120 2567911  
Email: [contact@rotopumps.com](mailto:contact@rotopumps.com)

### Branch Offices and Warehouses

#### United Kingdom

Unit 1 St Elizabeths Park, Grey Street, Denton, Manchester, M34 3RU  
Tel.: +44 161 4775511 Fax: +44 161 4747900  
Email: [sales@rotopumps.co.uk](mailto:sales@rotopumps.co.uk)

#### Australia

26, Deans Court, Dandenong South, Victoria 3175  
Tel.: +61 3 97945200 Fax: +61 3 97945900  
E mail: [melb@rotopumps.com.au](mailto:melb@rotopumps.com.au)

[www.rotopumps.com](http://www.rotopumps.com)

### Subsidiaries

#### Roto Pumpen GmbH

Am Brühl 17, 32423 Minden, Germany  
Tel: +49 571 40410077,  
Email: [sales@rotopumpen.de](mailto:sales@rotopumpen.de)

#### Roto Pumps North America, Inc.

5889 S Garnett Rd. Tulsa ,Oklahoma 74146  
Tel: +1 918 280 9144,Fax: +1 918 806 6853  
Email: [info@rotopumpsna.com](mailto:info@rotopumpsna.com)

#### Roto Pumps Africa (Pvt) Ltd

3, Sun Rock Close Germiston 1401, Africa  
Tel.: +27 10 100 3774  
Email: [sales@rotopumps.co.za](mailto:sales@rotopumps.co.za)